

Operating Instructions for FMF5, FMF5-SS, FMF7 & FMF7-SS Safety Switches

Description

The FMF5 and FMF7 safety switches are non-contact, magnetically operated switch and actuator. Designed to work with safety relays that have a low inrush current on the switch input, these switches provide an economical method of switching for the higher category, dual channel circuits.

These safety switches are available in a robust ABS, or 316 grade stainless steel housing, and both switch and actuator are fully sealed to IP67 making them suitable for use in wet or dusty environments. They are easy to install and tolerant to misalignment. With correct installation, these safety switches comply with the guidelines given in ISO EN14119.

A risk assessment should take place to establish that the specifications of these safety switches are suitable for the application required.

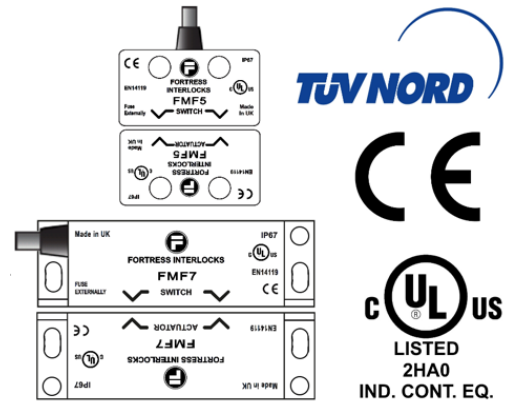

KEEP THIS GUIDE FOR FUTURE REFERENCE

The information is designed to help suitably qualified personnel install and operate Fortress Interlocks safety equipment. Before using this product, read this guide thoroughly along with any relevant European and/or National Standards E.g. Machinery Directive 2006/42/EC and its Amendments, Provision and Use of Work Equipment Regulations.

Further information can be obtained from Fortress Interlocks Ltd.

Technical Specifications	FMF5 / FMF5-SS	FMF7 / FMF7-SS
Contacts	Max 2 NO + 1 NC	Max 2 NO + 1 NC
Safety Contact Rating	24Vdc / 500mA	24Vdc / 500mA
Safety Contact Switching	7mm ON / 17mm OFF	7mm ON / 20mm OFF
Auxiliary Contact Rating	24Vdc / 500mA	24Vdc / 500mA
Auxiliary Contact Switching	7mm OFF / 17mm ON	7mm OFF / 14mm ON
External Fuse (customer supplied)	0.3 Amps Fast Acting	0.3 Amps Fast Acting
Construction	RED ABS or 316 Stainless Steel	RED ABS or 316 Stainless Steel
IP Rating	IP67 / IP69K	IP67 / IP69K
Operating Temperature	-25°C to +55°C	-25°C to +55°C
	-25°C to +125°C (HT)	-25°C to +70°C (PUR)
Fixing	M4 Torx security screws, Tightening 1.0NM	M4 Torx security screws, Tightening 1.0NM
Connection	Pre-wired or M12 Leaded Quick Disconnect	Pre-wired or M12 Leaded Quick Disconnect
Vibration / Shock	50 - 100 Hz 10g	50 - 100 Hz 10g

Safety Related Data

B10d	2,000,000	PFH	6.52×10^{-8}
TM (Mission Time)	> 20 Years	PFHd	4.3×10^{-8} See Note 1
DC	99%	SFF	98%
MTTFd	High > 100 Years (Based on usage rate of 360 Days/Year, 24 Hours/Day, 10 Operations/Hour)		

Note 1: Based on dual channel wiring according to CAT 4. Diagnostic coverage provided by downstream control logic. DC - medium, MTTFd = 100 Years. Suitable for performance level applications PLe according to ISO 13849-1. (SIL 3 or SIL 2 according to IEC 62061)

Safety Standards

Approvals	CE Complies with all relevant sections of the CE Marking Directive cUL 508 Industrial Control, TÜV Approved
International Directives	Machinery Directive 2006/42/EC, Low Voltage Directive 2014/35/EU; EMC Directive 2014/30/EU, RoHS Directive 2011/65/EC
International Standards	BS EN 12100 Safety of Machinery. General principles for design. BS EN ISO 14119 Safety of Machinery. Interlocking devices associated with guards. Principles for design and selection. BS EN ISO 13849 Safety of Machinery. Safety related parts of control systems. BS EN ISO 62061 Safety of Machinery. Functional safety of safety related electrical, electronic and programmable electronic control systems BS EN 60204 Safety of Machinery. Electrical equipment of machines. BS EN 60947-5-1 Low-voltage switchgear and controlgear. BS EN 60947-5-3 Low-voltage switchgear and controlgear.

Operating Instructions for FMF5, FMF5-SS, FMF7 & FMF7-SS Safety Switches

Dimensions

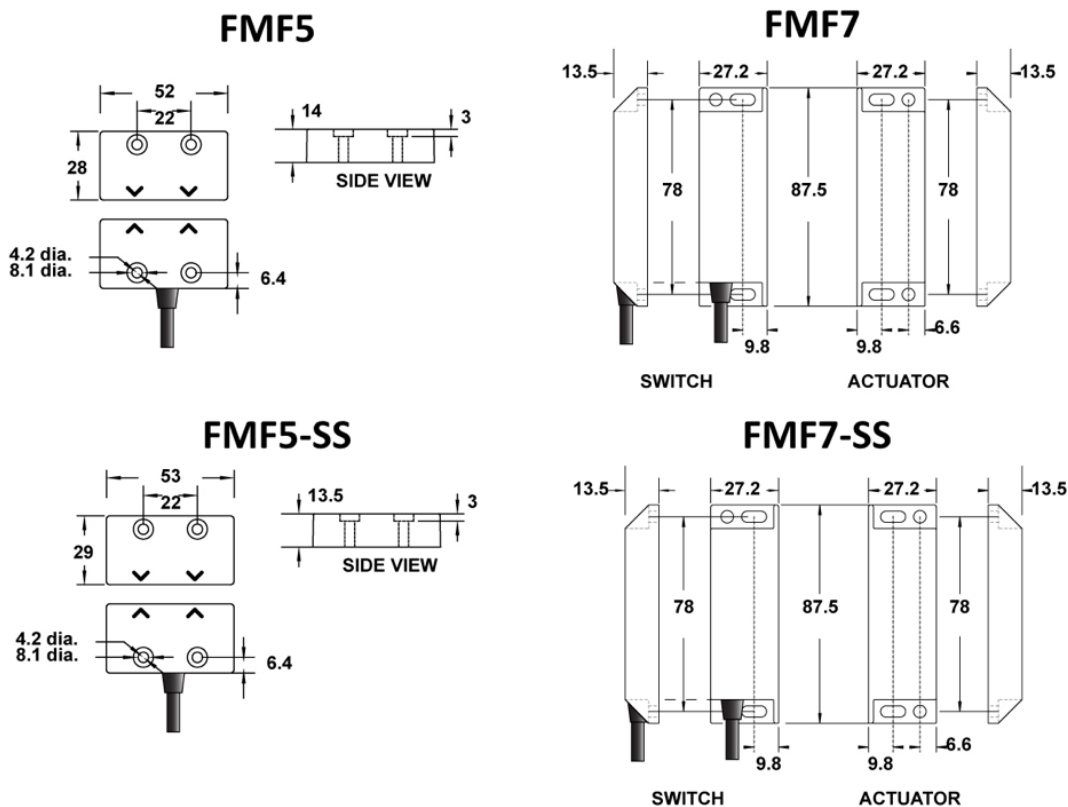

Operation

The FMF5 & FMF7 safety switches and actuators are designed to approach each other from most angles. When the guard is closed the targets on the printed face of the switch and actuator must be aligned.

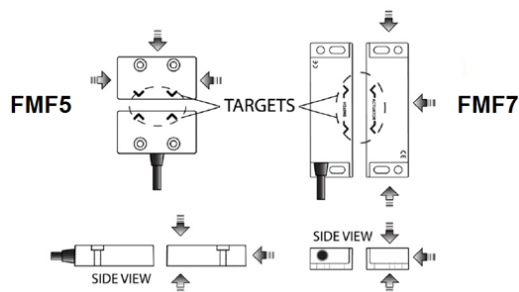

Mounting

Do not use safety switches as a stop. 1 mm separation when closed provides the best results.

Mount the switch on to the machine frame and the actuator on to the opening edge of the door.

Always try to mount the switch on non-ferrous material. (Ferrous materials may reduce the switching distance).

Minimum separation 50mm between adjacent switches

DO NOT mount on hinged side of the guard.

ISO EN14119: Hide the switch / actuator where possible.

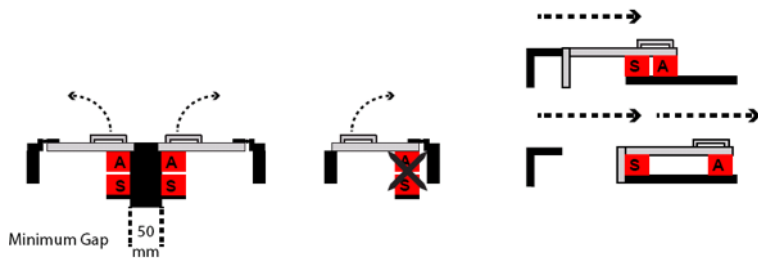

Operating Instructions for FMF5, FMF5-SS, FMF7 & FMF7-SS Safety Switches

Connections & Fuses

PRE-WIRED

FMF5-21 & FMF5-SS-21
FMF7-21 & FMF7-SS-21

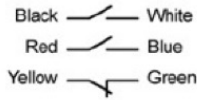

FMF5-SS-21-HT
(High Temp)

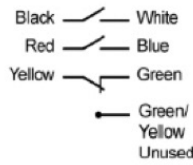

FMF5-SS-21-PUR
(PUR Cable)

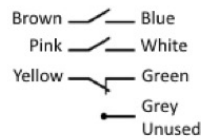

LEADED QUICK DISCONNECT

Connector Contact Cable

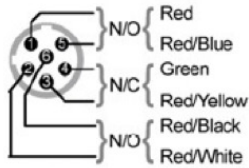

Connector
Micro 1/2" UNF
6 pole, Dual Key Way

LEADED QUICK DISCONNECT OPTION LQD 150mm Cable with M12 Connector

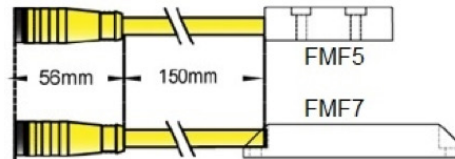

The NO contacts on the FMF5 and FMF7 safety switches are open when the actuator is away from the switch. When the actuator is within the specified operating distance the NO contact(s) will close and the NC contact will open.

All safety contacts should be externally fused. 0.3 Amps Fast Acting

Switching Characteristics

The chart shows the switching points in millimetres

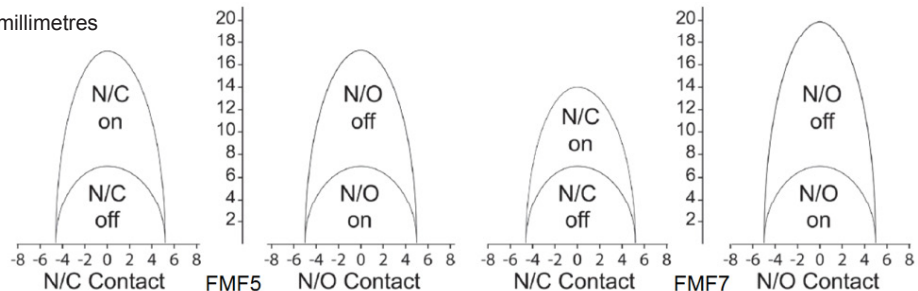

Operating Instructions for FMF5, FMF5-SS, FMF7 & FMF7-SS Safety Switches

Recommended Safety Control Unit

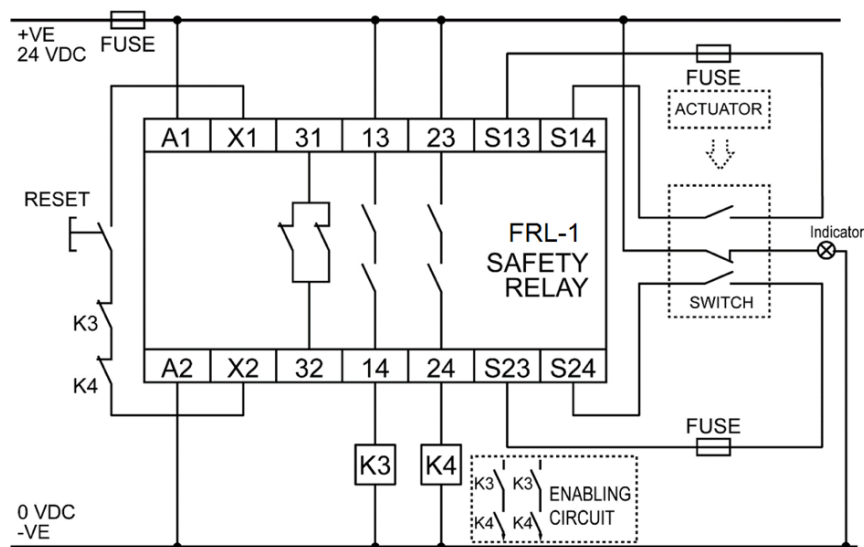

IMPORTANT

CONNECTION TO A SAFETY RELAY

The FMF5 & FMF7 non-contact safety switches are designed to work with safety relays that have a low inrush current on the switch input.

All control contacts should be externally fused.

Recommended Safety Control Unit Fortress Part Number: FRL-1 24VAC/DC or FEM1 & FMX1

Maintenance

It is recommended to check the safe operation of the switches and look for signs of damage or excessive wear on a weekly basis. Damaged units should be replaced or returned to the manufacturer for repair where practical.

Notes

In the interest of product development specifications are subject to change without notice. It is the responsibility of the user to ensure compliance with any acts or by-laws in place. All information regarding Fortress equipment is believed to be accurate at the time of printing. Responsibility cannot be accepted for errors or omissions.